









PROJECT		REF		REV	ITEM CODE	
LOCATION		DATE			PAGE	

SANITARY WARE SPECIFICATION SHEET

Item Descriptions	Bumhan (South Korea) Chrome plated robe hook	<p>Illustration/ Drawing</p>      
Dimensions	L72 x W65 x H45mm	
Model	KH-514S-5	
Material	Chrome Plated	
Manufacturer	Bumhan Industry Co., Ltd	
Source	Ka Shing Enterprises (H.K) Limited Mr. Ivan Lau / Mr. GilmanYuen	
Contact Tel/Fax	(852) 2628-0661 / (852) 2490-2700	
E-mail	project@kashingehk.com	
Website	www.kashingehk.com	

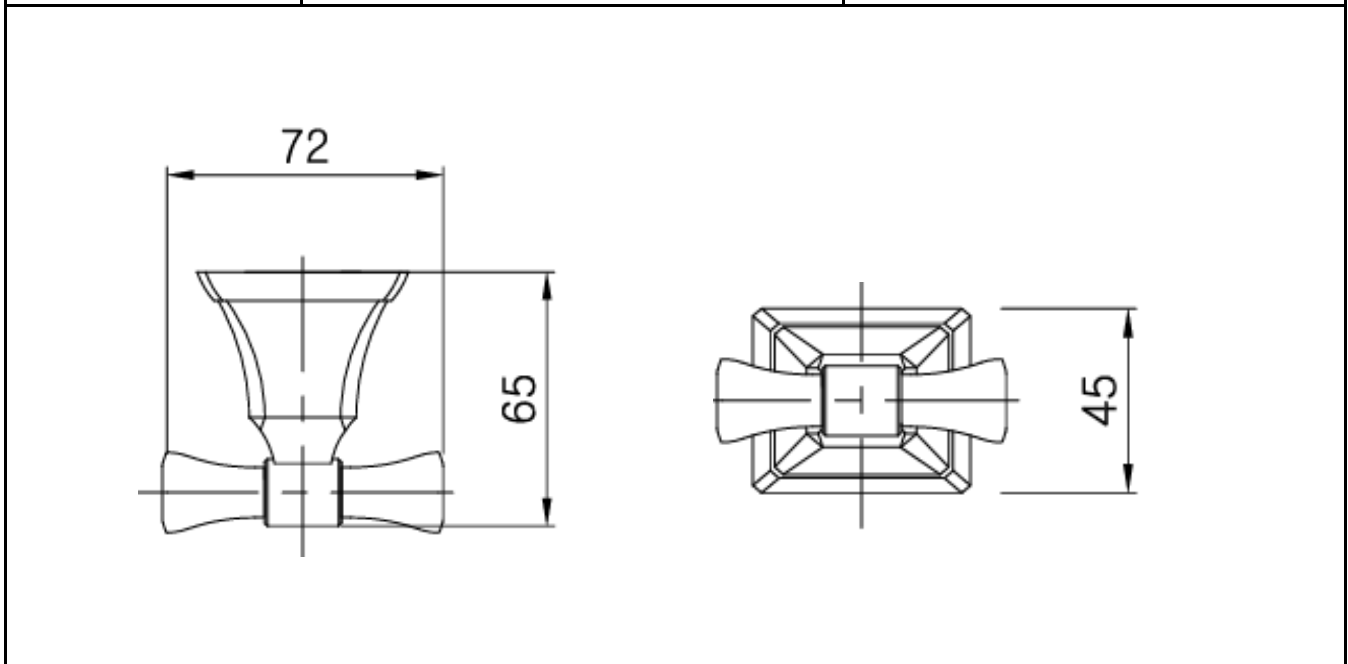

Note:

* All information of the above is for reference only. No prior notice is made if any changes.