

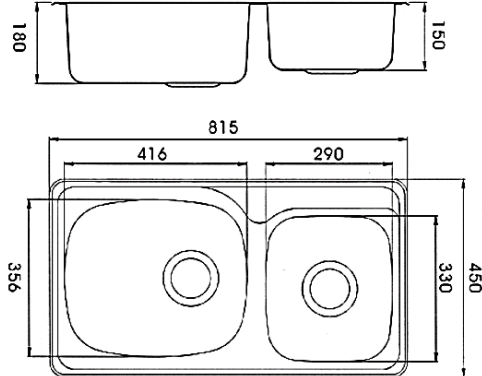

PROJECT		REF		REV	ITEM CODE	
LOCATION		DATE			PAGE	

SANITARY WARE SPECIFICATION SHEET

<p>Item Descriptions</p> <p>Dimensions</p> <p>Model</p> <p>Material</p> <p>Manufacturer</p> <p>Source</p> <p>Contact Tel/Fax</p> <p>E-mail</p> <p>Website</p>	<p>Idecor (PRC) 304 Stainless steel double bowls insert sink with waste fittings and overflow hole</p> <p>L815 x W450 x H180 mm (Overall) L416 x W356 x H180 mm (Large) L290 x W330 x H150 mm (Small)</p> <p>E3511</p> <p>Stainless Steel 304</p> <p>Idecor (PRC)</p> <p>Ka Shing Enterprises (H.K) Limited Mr. Ivan Lau / Mr. GilmanYuen</p> <p>(852) 2628-0661 / (852) 2490-2700 project@kashingehk.com www.kashingehk.com</p>	<p>Illustration/ Drawing</p>  
<p>Product Detail :</p> <p>"Flat rim sinks"</p> <ul style="list-style-type: none"> Model : E3511 Size (mm) : 815 mm x 450 mm x 180 mm Size (inch) : 32" x 18" x 7" CUT-OUT (mm) : 788 mm x 425 mm 304 Stainless steel double bowls sink 		

Note:

* All information of the above is for reference only. No prior notice is made if any changes.