

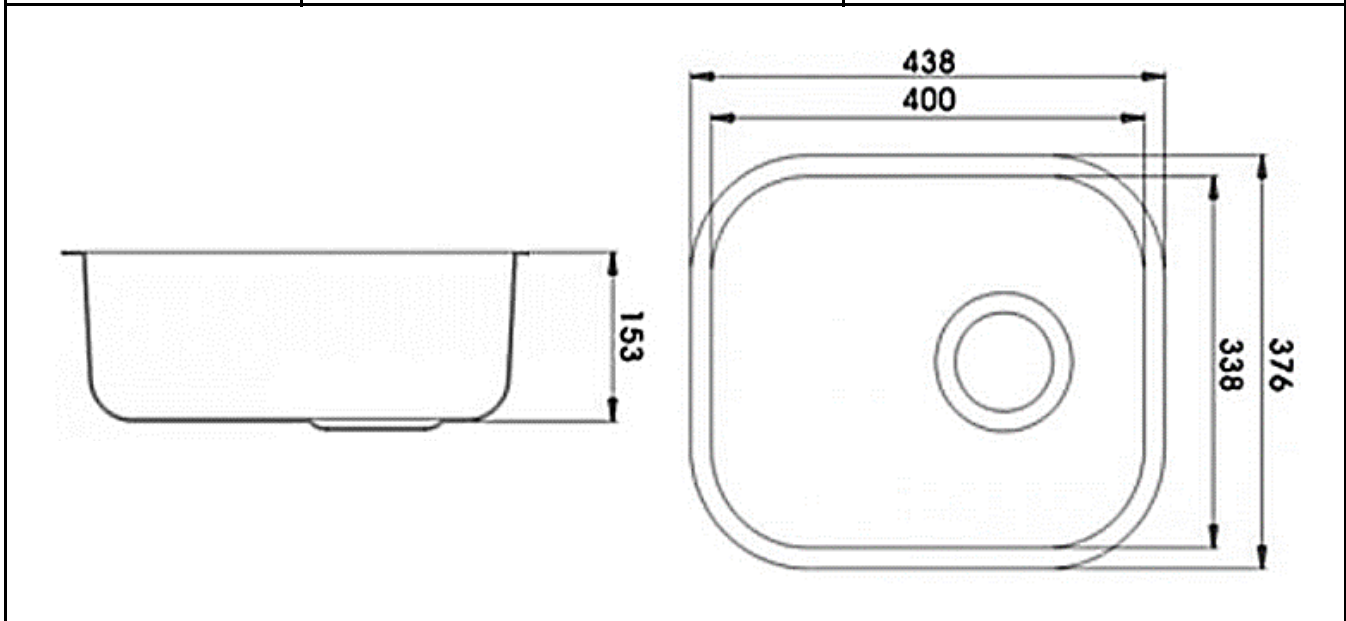

PROJECT		REF		REV	ITEM CODE	
LOCATION		DATE			PAGE	

SANITARY WARE SPECIFICATION SHEET

Item Descriptions	Global (PRC) 304 Stainless steel single bowl insert sink with waste fittings	Illustration/ Drawing
Dimensions	L438 x W376 x H153 mm (Overall) L400 x W338 x H153 mm (Bowl)	
Model	U1004	
Material	Stainless Steel 304	
Manufacturer	Global (PRC)	
Source	Ka Shing Enterprises (H.K) Limited Mr. Ivan Lau / Mr. GilmanYuen	
Contact Tel/Fax	(852) 2628-0661 / (852) 2490-2700	
E-mail	project@kashingehk.com	
Website	www.kashingehk.com	



Note:

** All information of the above is for reference only. No prior notice is made if any changes.*