

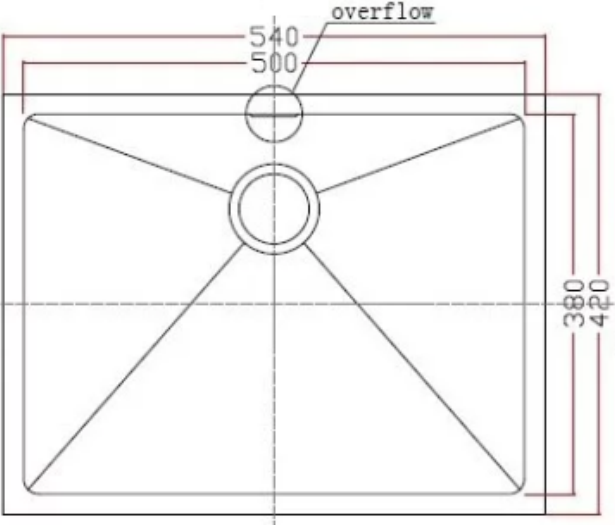

PROJECT		REF		REV	ITEM CODE	
LOCATION		DATE			PAGE	

SANITARY WARE SPECIFICATION SHEET

Item Descriptions	Idecor (PRC) 1.2mm thickness 304 Stainless Steel single bowl insert sink with waste fittings and overhole hole (Round Corners)	<p>Illustration/ Drawing</p> 
Dimensions	L540 x W420x H200mm (Overall) L500 x W380x H200mm (Bowl)	
Model	U1147	
Material	Stainless Steel 304	
Manufacturer	Idecor (PRC)	
Source	Ka Shing Enterprises (H.K) Limited Mr. Ivan Lau / Mr. GilmanYuen	
Contact Tel/Fax	(852) 2628-0661 / (852) 2490-2700	
E-mail	project@kashingehk.com	
Website	www.kashingehk.com	



iDECOR
Confidence Comes From The Outstanding Quality

全304不銹鋼材料生產
全線預設滿水孔
防倒汗水塗層及隔音綿功能

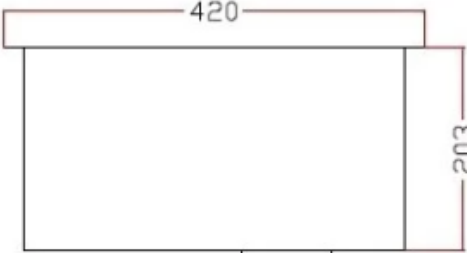

Note:

* All information of the above is for reference only. No prior notice is made if any changes.