

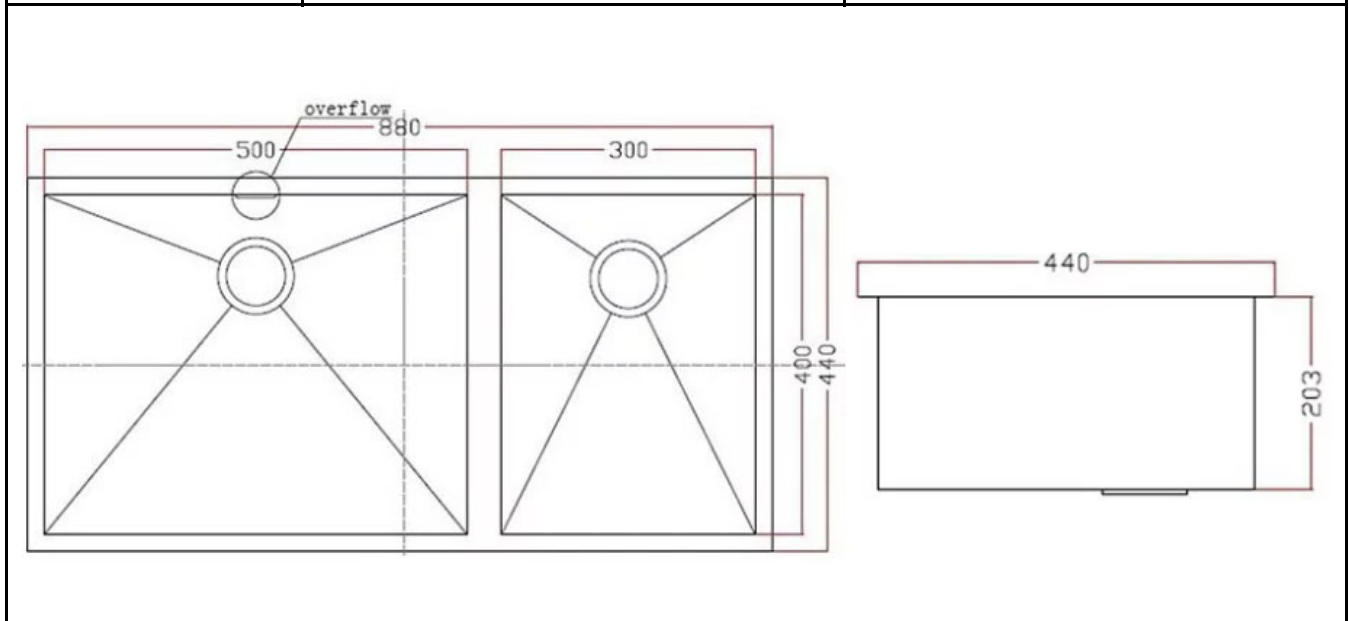

PROJECT		REF		REV	ITEM CODE	
LOCATION		DATE			PAGE	

**SANITARY WARE SPECIFICATION SHEET**

Item Descriptions	Idecor (PRC) 1.2mm thickness 304 Stainless Steel double sink bowl insert sink with waste fittings and overhole hole (Round Corners)	<p>Illustration/ Drawing</p> 
Dimensions	L880 x W440 x H203mm (Overall) L500 x W400 x H200mm (Large) L300 x W400 x H200mm (Small)	
Model	U3125	
Material	Stainless Steel 304	
Manufacturer	Idecor (PRC)	
Source	Ka Shing Enterprises (H.K) Limited Mr. Ivan Lau / Mr. GilmanYuen	
Contact Tel/Fax	(852) 2628-0661 / (852) 2490-2700	
E-mail	project@kashingehk.com	
Website	www.kashingehk.com	



Note:

\* All information of the above is for reference only. No prior notice is made if any changes.