

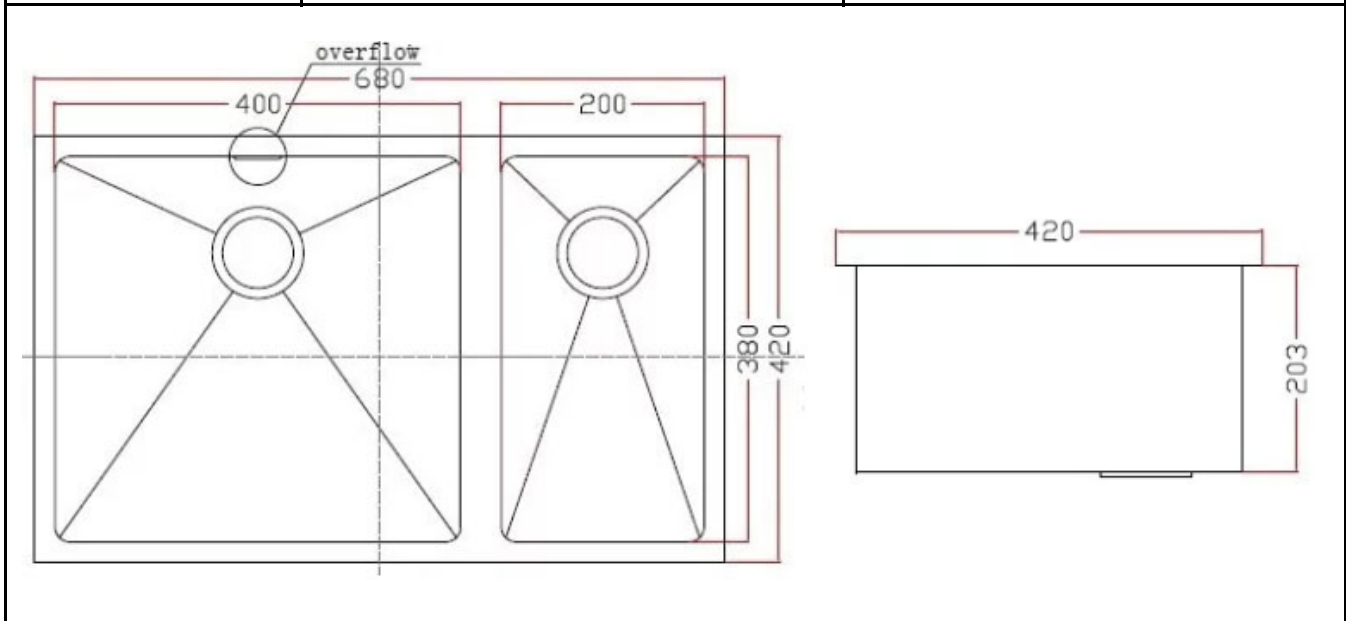

PROJECT		REF		REV	ITEM CODE	
LOCATION		DATE			PAGE	

SANITARY WARE SPECIFICATION SHEET

Item Descriptions	Idecor (PRC) 1.2mm thickness 304 Stainless Steel double sink bowl insert sink with waste fittings and overhole hole (Round Corners)	<p>Illustration/ Drawing</p> 
Dimensions	L680 x W420 x H203mm (Overall) L400 x W380 x H200mm (Large) L200 x W380 x H200mm (Small)	
Model	U3147	
Material	Stainless Steel 304	
Manufacturer	Idecor (PRC)	
Source	Ka Shing Enterprises (H.K) Limited Mr. Ivan Lau / Mr. GilmanYuen	
Contact Tel/Fax	(852) 2628-0661 / (852) 2490-2700	
E-mail	project@kashingehk.com	
Website	www.kashingehk.com	



Note:

* All information of the above is for reference only. No prior notice is made if any changes.