



# Ka Shing Enterprise (H.K.) Ltd.

ROOM 1706 NEW TERRITORIES TSUEN WAN HO LIK CENTRE, 66A SHA TSUI ROAD







Tel:26280661 Fax: 24902700

Email: project@kashingehk.com

Website: www.kashingehk.com

PROJECT		REF		REV	ITEM CODE	
LOCATION		DATE			PAGE	

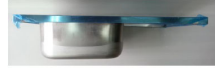
## SANITARY WARE SPECIFICATION SHEET

Item Descriptions	YY (PRC) 304 Stainless steel single end bowl insert lay-on sink with waste fittings; complies with: BS EN 1244: 1988;test report <b>RHSF005</b>	<p>Illustration/ Drawing</p>      
Dimensions	L1220 X W160 x H180 mm (Overall) L375 x W330 x H180 mm (Bowl)	
Model	YY-25336D	
Material	Stainless Steel 304	
Manufacturer	YY(PRC)	
Source	Ka Shing Enterprises (H.K) Limited Mr. Ivan Lau / Mr. GilmanYuen	
Contact Tel/Fax	(852) 2628-0661 / (852) 2490-2700	
E-mail	project@kashingehk.com	
Website	www.kashingehk.com	

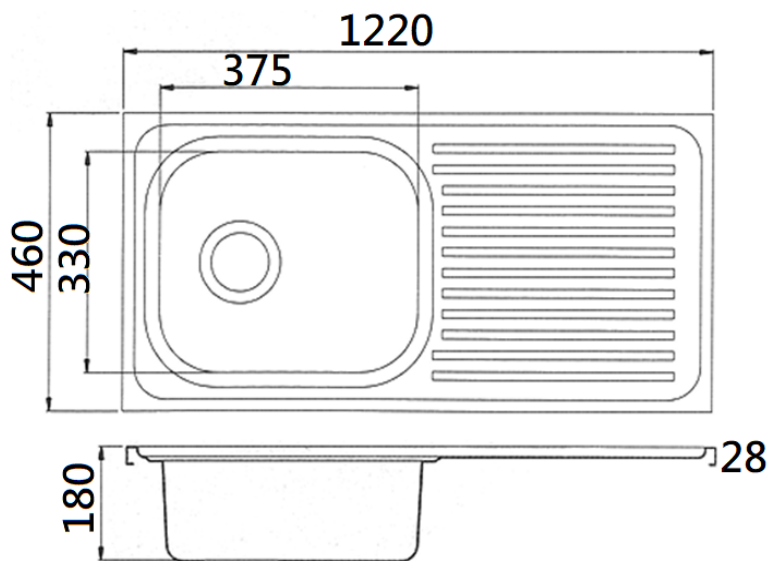

Note:

\* All information of the above is for reference only. No prior notice is made if any changes.



**TEST REPORT**



TITLE : Testing of kitchen sink

OUR REFERENCE : RHSF005

DESCRIPTION OF SAMPLE : Stainless steel kitchen sink; single bowl; size: 1220mm x 460mm x 0.8mm

SAMPLE SUBMITTED BY :

BRAND : /

BODY MARKINGS : 

MODEL : YY-25336D

ORIGIN : China

METHOD OF TESTS : BS1244 : Part 2 : 1988

PERIOD OF TESTS : 13<sup>th</sup> to 19<sup>th</sup> June 2018

**RESULTS: -** (apply only to the sample tested)  
1. DIMENSIONS (in millimetres)

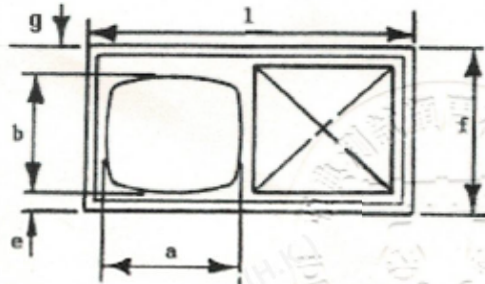

		Sample	BS Requirement
Overall length	L	1220	/
Overall width	f	460	515 max. for 600 Cabinet
Depth of bowl measured form the top edge of the bowl to the deepest part	/	180	180 min.
Internal length of bowl measured on the bowl centre lines across the top of the bowl	a	375	380 min.
Internal width of bowl measured on the bowl centre lines across the top of the bowl	b	330	340 min.
Minimum distance between the edge of sink bowl and the end of the sink	e	65	45 min.
Waste hole diameter	/	51.2	/
Minimum thickness	/	0.83	0.83 min.
Minimum distance between the edge of sink bowl and the end of the sink	g	65	/



9 Apr 2019  
**CERTIFIED TRUE COPY**

(P.2)

2. CHEMICAL COMPOSITION

Component	Element compositions (%)							Designation to BSEN10088-3 2014
	C	Si	Mn	Ni	Cr	S	P	
Sample	0.06	0.6	1.0	8.3	18.1	0.017	0.025	1.4301
Requirement	≤ 0.07	≤ 1.0	≤ 2.0	8.0-10.5	17.5-19.5	≤ 0.03	≤ 0.045	1.4301

3. SUMMARY OF RESULTS (apply only to the sample tested)

Dimensions -- As shown in section 1.

Chemical compositions -- Satisfactory; the test results comply with BSEN10088-3 2014 Stainless Steel grade 1.4301

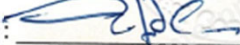
Date : 9 Apr 2019 Authorized signature :   
**Wong K.S. Sunny**  
 ( Director )