



Ka Shing Enterprise (H.K.) Ltd.

ROOM 1706 NEW TERRITORIES TSUEN WAN HO LIK CENTRE, 66A SHA TSUI ROAD





Tel:26280661 Fax: 24902700

Email: project@kashingehk.com

Website: www.kashingehk.com

PROJECT		REF		REV	ITEM CODE	
LOCATION		DATE			PAGE	

SANITARY WARE SPECIFICATION SHEET

Item Descriptions	YY (PRC) 304 Stainless steel single end bowl insert lay-on sink with waste fittings; complies with: BS 1244-2: 1988;BS 1449-2 : 1983 & BS EN 10088-3:2014 test report RHSF007C	<p>Illustration/ Drawing</p>      
Dimensions	L1067 X W458 x H188 mm (Overall) L408 x W348 x H180 mm (Bowl)	
Model	YY-22335	
Material	Stainless Steel 304	
Manufacturer	YY(PRC)	
Source	Ka Shing Enterprises (H.K) Limited Mr. Ivan Lau / Mr. Gilman Yuen	
Contact Tel/Fax	(852) 2628-0661 / (852) 2490-2700	
E-mail	project@kashingehk.com	
Website	www.kashingehk.com	

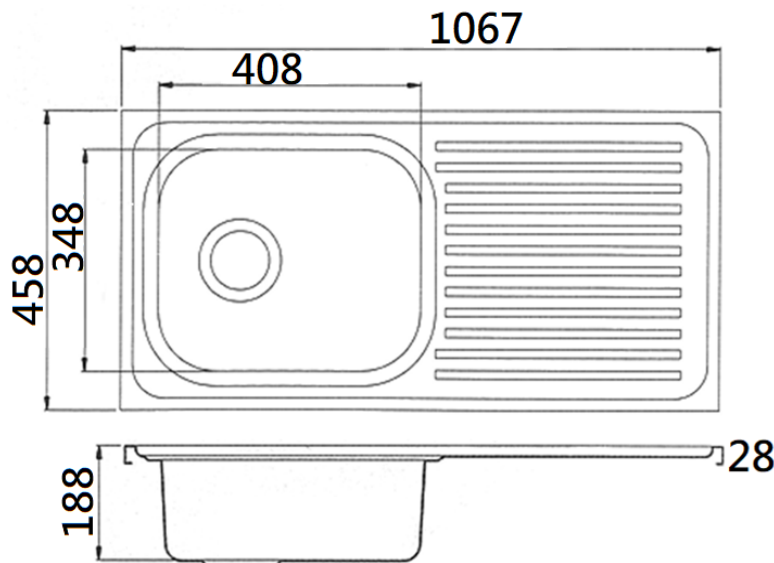

Note:

* All information of the above is for reference only. No prior notice is made if any changes.



IDEAL Test Consultants Ltd.
亞典測試顧問有限公司

Unit 18, 8/F., World-Wide Industrial Ctn,
43 - 47 Shan Mei Street,
Fo Tan, N.T. H.K.
Tel: 3702 1986 Fax: 3702 1987
Email: sunny@idealtest.com.hk

TEST REPORT

REPORT REFERENCE NO. : **RHSF007C**
TITLE : Testing of Kitchen sink
METHOD OF TEST : BS1244-2: 1988, BS1449-2: 1983 & BSEN10088-3: 2014
PERIOD OF TESTS : 16th Sep., 2022 to 10th Oct., 2022
SAMPLE SUBMITTED BY :
(Information below provided by client)

DESCRIPTION OF SAMPLE : Stainless steel kitchen sink; single bowl; size: 18" x 42"
BRAND : Nil
MODEL : YY-22335
BODY MARKING : 
MANUFACTURER : Nil
COUNTRY OF ORIGIN : China



SUMMARY OF RESULTS :

(Definition of 'C' – Conformance, 'NC' – Non – Conformance & '/' – No requirement)

Test	Overall result
1. Dimension	C
2. Materials	C

Date: 11 Oct. 2022

Authorized signature: _____

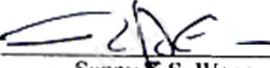

Sunny K.S. Wong
(Director)



Report reference no.: RHSF007C

RESULTS: - (apply only to the sample tested)

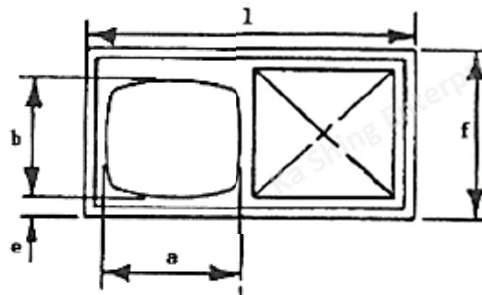
1. Dimension (mm)
(BS1244-2: 1988, clause 13)



		Sample	BS Requirement	Remark
Overall length	l	1067	/	/
Overall width	f	458	515 max. for 600 cabinet	C
Depth of bowl measured from the top edge of the bowl to the deepest part, including the double recess for the waste outlet.	/	188	180 min.	C
Internal length of bowl measured on the bowl centre lines across the top of the bowl	a*	408	/	/
Internal width of bowl measured on the bowl centre lines across the top of the bowl	b*	348	/	/
Minimum distance between the edge of sink bowl and the end of the sink	e	56	45 min.	C
Waste hole diameter	/	57	/	/
Minimum thickness of material before forming	/	0.92	0.83 min.	C
Overall result				C

* There is no restriction on bowl shape provided the minimum dimensions given in this clause are complied with. Dimensions given are minimum dimensions unless otherwise stated.

2. Materials

(Designation to BS1244-2: 1988 clause 6, BS1449-2: 1983 & BSEN10088-3: 2014)

Variable	Unit	Measured	Required			Remark
			BS1449 part 2: 1983 Grade 304S15	BS1449 part 2: 1983 Grade 304S31	BSEN10088-3: 2014 Grade 1.4301	
C - Carbon	%	0.06	≤ 0.06	≤ 0.07	≤ 0.07	C
Si - Silicon	%	0.34	≤ 1.00	≤ 1.00	≤ 1.00	C
Mn - Manganese	%	0.94	≤ 2.00	≤ 2.00	≤ 2.00	C
Ni - Nickel	%	8.42	8.0-11.0	8.0-11.0	8.0-10.5	C
Cr - Chromium	%	18.23	17.5-19.0	17.0-19.0	17.5-19.5	C
S - Sulphur	%	0.018	≤ 0.030	≤ 0.030	≤ 0.030	C
P - Phosphorus	%	0.015	≤ 0.045	≤ 0.045	≤ 0.045	C
N - Nitrogen	%	0.06	/	/	≤ 0.10	C
Overall result						C

- End of report -