

SANITARY WARE SPECIFICATION SHEET

Model: TF6727B

Descriptions: American Standard (Thailand) "Contour" Vitreous china wall hung back inlet urinal bowl Water flush volume 1.5 litres/cycle in WELS Grade 1 ; Registration No. 1U 20-0004

Dimensions: L324 x W355 x H758 mm

Material : Vitreous China

Manufacturer: American Standard (PRC)

Color : White

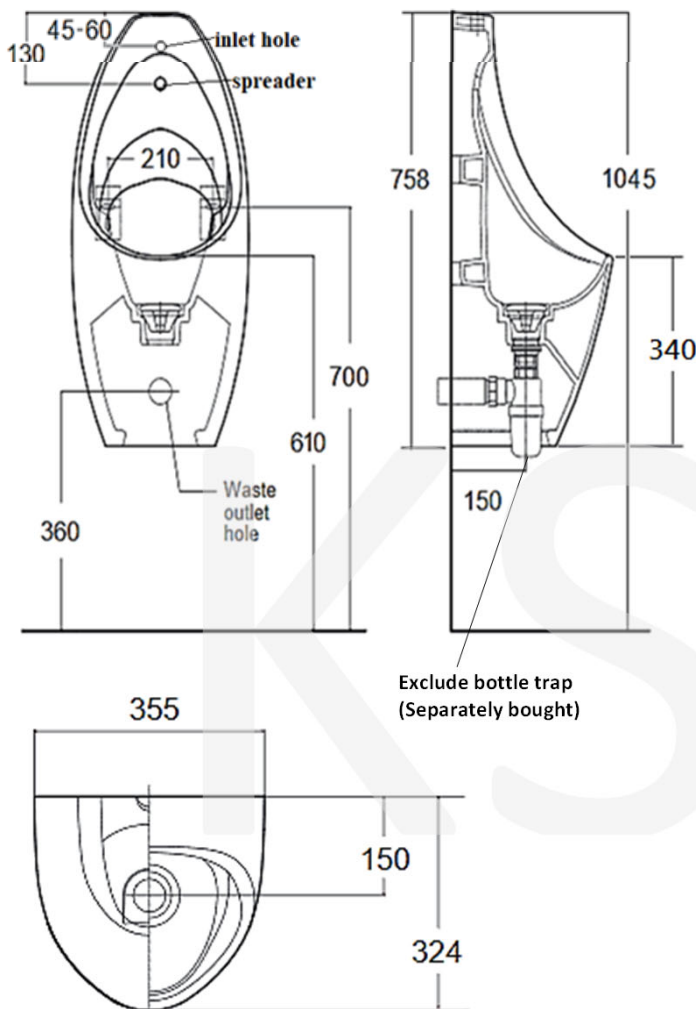

* All information of the above is for the reference only. No prior notice is made if any changes.



Ka Shing Enterprise (H.K.) Ltd.

ROOM 1706 NEW TERRITORIES TSUEN WAN HO LIK CENTRE, 66A SHA TSUI ROAD
Tel:26280661 Fax: 24902700
Email: project@kashingehk.com
Website: www.kashingehk.com

Ivan / Horace 26280661

E/ project@kashingehk.com

W/ <http://www.kashingehk.com/>

註冊號碼 (Registration No.): 1U 20-0004



自願參與用水效益標籤計劃 - 小便器用具
Voluntary Water Efficiency Labelling Scheme - Urinal Equipment



Certificate of Registration

註冊證書

茲證明

This is to certify that

將下列小便器用具在本計劃內註冊：
has registered the following urinal equipment under this scheme:

牌子 / Brand	:	American Standard
型號 / Model	:	6727B-WT
種類 / Category	:	1
原產地 / Country or Region Origin	:	Thailand

在用水效益標籤上展示的標誌 <i>Symbolic Presentation on the Water Efficiency Label</i>	:		滴水點 <i>Water droplet(s)</i>
用水效益級別 <i>Water Efficiency Grade</i>	:	1	
沖水量 <i>Water Flush Volume</i>	:	1.5	公升/循環 <i>litres/cycle</i>

簽發日期：
Date of Issue: 20 April 2020

 水務署
Water Supplies Department



水務署署長(張業駒代行)
for Director of Water Supplies

上述小便器用具具有智能功能，並且能達至額外節省用水。
The above urinal equipment is operated with a smart demand operation to achieve additional water saving.

PREPARATION THE AREA / เตรียมพื้นที่

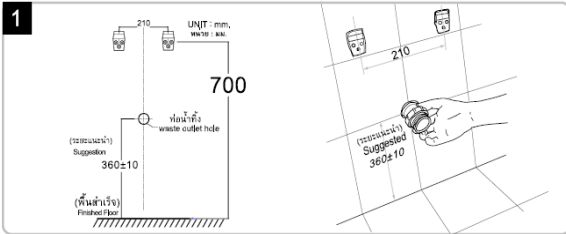

SPREADER SET INSTALLATION / การติดตั้งชุดหัวพ่นน้ำ

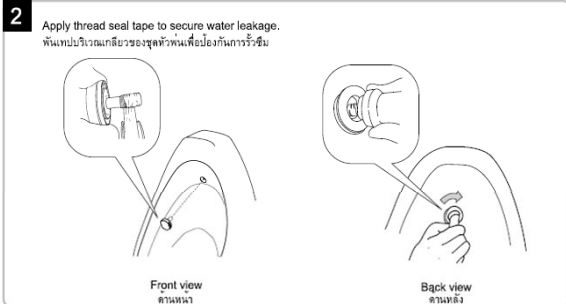

SPUD SET AND BOTTOM TRAP INSTALLATION / การติดตั้งชุดท่อน้ำทิ้งโถปัสสาวะ

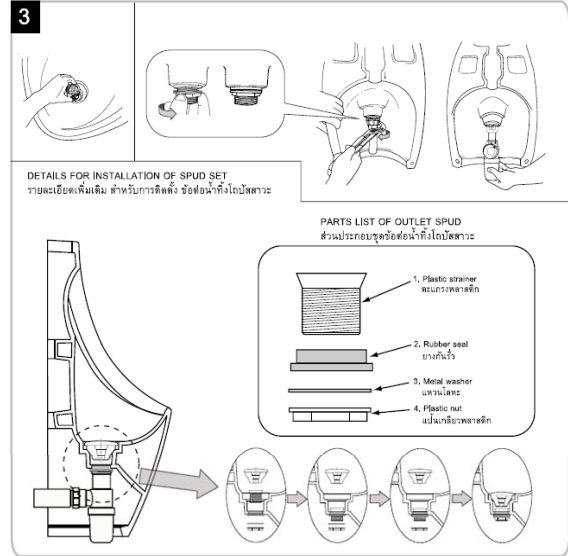

BACK INLET AND TOP INLET INSTALLATION

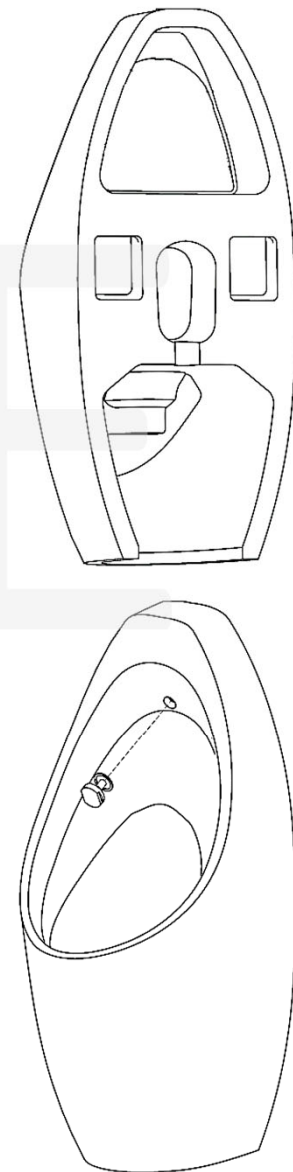
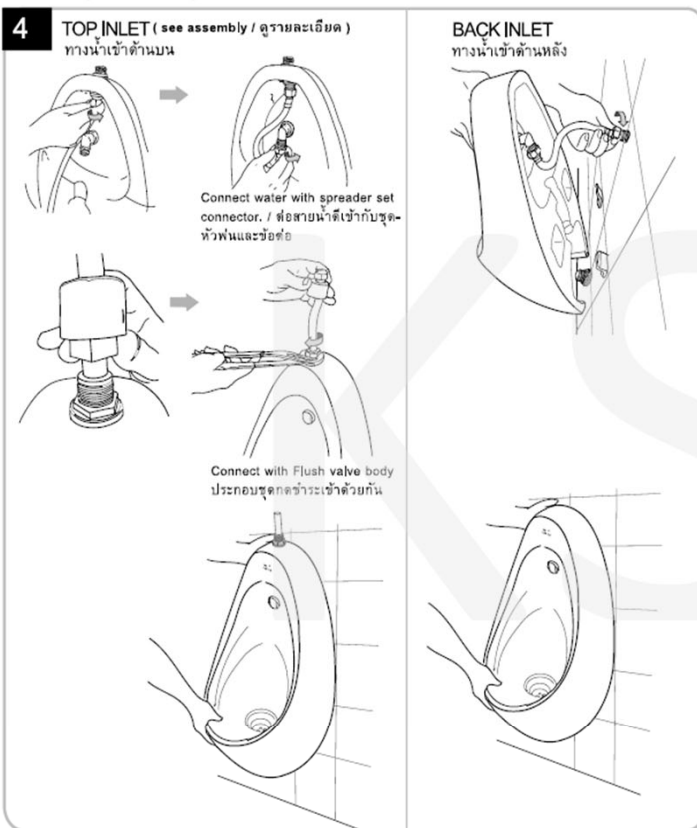

WASTE PIPE INSTALLATION

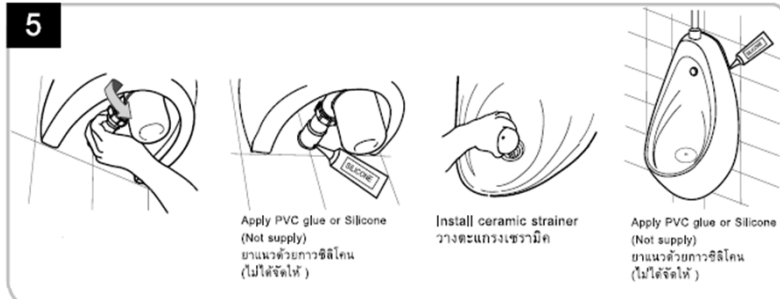

Ka Shing Enterprise (H.K.) Ltd.

ROOM 1706 NEW TERRITORIES TSUEN WAN HO LIK CENTRE, 66A SHA TSUI ROAD
Tel:26280661 Fax: 24902700
Email: project@kashingehk.com
Website: www.kashingehk.com

Ivan / Horace 26280661

E/ project@kashingehk.com

W/ https://www.kashingehk.com/