

SANITARY WARE SPECIFICATION SHEET

Model: M09AC

Descriptions: Mediclinics "Machflow® " (Spain) Stainless steel AISI 304 wall-mounted automatic hand dryer in bright finish

Dimensions: L213 x W170 x H330 mm

Material : Stainless steel

Manufacturer: Mediclinics, S.A. (Spain)

Finish : Bright Finish



* All information of the above is for the reference only. No prior notice is made if any changes.



Ka Shing Enterprise (H.K.) Ltd.

ROOM 1706 NEW TERRITORIES TSUEN WAN HO LIK CENTRE, 66A SHA TSUI ROAD
Tel:26280661 Fax: 24902700
Email: project@kashingehk.com
Website: www.kashingehk.com

Ivan / Horace 26280661

E/ project@kashingehk.com

W/ <https://www.kashingehk.com/>



M09A



M09AB



M09AC



M09ACS

General description

- Sensor operated Machflow Plus hand dryer, available in steel, white or black finish and in AISI 304 stainless steel, bright or satin finish.
- With a compact and very robust design, this hand dryer is energetically very efficient and sustainable, providing great energy savings and ultra-fast hand drying. Strongly recommended for high traffic places.
- It has an adjustable power motor that regulates energy consumption (between 420 and 1,500W) and provides a maximum air output speed of 325 km/h that dries your hands between 10 and 15 seconds.
- Machflow Plus can incorporate, optionally, a HEPA media filter that filters the solid particles in suspension (pollen, dust mites, tobacco smoke, etc.) significantly improving air quality.
- As a complement to the HEPA media filter, and also optionally, the Machflow Plus can incorporate an ionizer ("Ion Hygienic" technology) that cleans and purifies the air through the emission of anions, eliminating most of the germs and particles transported through the air, helping it to be purer and healthier.
- Optionally, it is also possible to incorporate a quick assembly / disassembly kit for the machine ("Plug-in" kit code KTP009) that allows you to install and uninstall the hand dryer easily, quickly and safely, making maintenance much more efficient and reducing your costs at the same time.
- New air concentrator nozzle which helps to channel better the airflow on the hands. Instead of blowing air all over the hands, it focuses the airflow for a more targeted drying. The narrower opening of the concentrator gives the airflow greater pressure on exit, boosting its speed and thus, making the hand drying process much more efficient.
- It has an odor neutralizer, code RCPOM14 that aromatizes and deodorizes the environment thanks to its soft fragrance (optional).
- Machflow Plus is equipped with an automatic safety disconnection system that switches it off automatically after 60 seconds of continuous use.
- It is supplied as standard with all the elements to fix it to a brick wall.

Technical Specifications

Voltage	220- 240 V
Frequency	50/60 Hz
Electrical Isolation	Clase I
Total power	420 – 1,500 W
Consumption	3.2 – 6.4 A
Standby consumption	0.3 W
Motor power	420 – 1,100 W
Rpm	19,000 – 30,000
Heating element power	400 W (interruptor "ON/OFF")
Dimensions	330x213x170 mm
Weight	5.1 Kg
Cover thickness	1.5 mm
Drying time	10-15"
Effective airflow	115-180 m ³ /h – 1,917-3,000 L/min
Air velocity	190 – 480 Km/h
Air temperature (10 cm distance/21°C)	45 °C
Sound pressure (*) (at 2m)	67-74 dBA
Protection rating	IP23

(*) According to UNE EN ISO 11201:2010 V2 standard

Dimensions

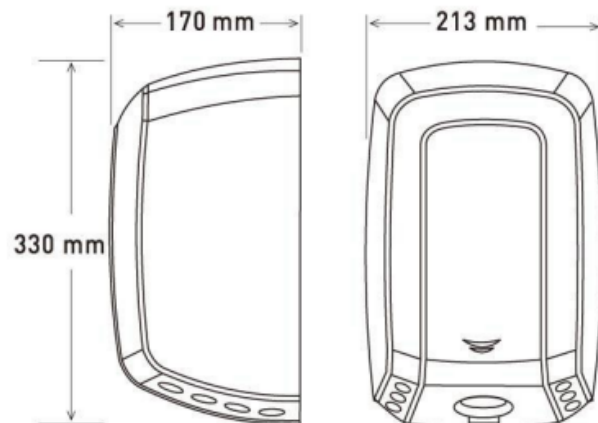

Dimensions: ± 4%



Ka Shing Enterprise (H.K.) Ltd.

ROOM 1706 NEW TERRITORIES TSUEN WAN HO LIK CENTRE, 66A SHA TSUI ROAD
Tel:26280661 Fax: 24902700
Email: project@kashingehk.com
Website: www.kashingehk.com

Ivan / Horace 26280661

E/ project@kashingehk.com

W/ <https://www.kashingehk.com/>

Components and materials

- **COVER:** made of steel (M09A... and M09AB...) or AISI 304 stainless steel (M09AC... and M09ACS...) of 1.5 mm thickness, in one piece without welding.
- **BASE PLATE:** made with PA6V0 fire resistant plastic. It incorporates 4 silent-blocks to cushion mechanical vibrations.
- **INTERIOR SET:** made of PA6V0 fire resistant plastic.
- **MOTOR:** vacuum universal brush motor, F class. Speed may be adjusted manually between 19.000 and 30.000 rpm by means of a potentiometer.
- **HEATING ELEMENT:** minimum waved wire NiCr heating element of 400W, mounted on a mica frame that incorporates a self-resetable thermal cut-off which disconnects the whole appliance. The heating element can be disconnected by means of a ON/OFF switch.
- **HANDS DETECTION SYSTEM:** fully adjustable IR electronic detection sensor by means of a potentiometer. Detection distance can be adjusted between 5 and 25 cm. It has an automatic disconnection system after 60 "of continuous use.
- **HEPA MEDIA FILTER:** which filters the solid particles in suspension (pollen, dust mites, tobacco smoke, etc.) significantly improving air quality (optional).
- **IONIZER:** cleans and purifies the air through negative ions (anions) that remove microscopic particles from the air and make it healthier (optional).
- **ODOR NEUTRALIZER:** aromatizes and deodorizes the environment through its soft fragrance (optional).

OPERATION

Place the hands under the air outflow valve. The dryer will start automatically, and go on with no interruption as long as the hands are kept in the detection range of the sensor. The appliance will stop 2 seconds after the hands are removed from the airflow or 60 seconds after continuous working.

MOUNTING

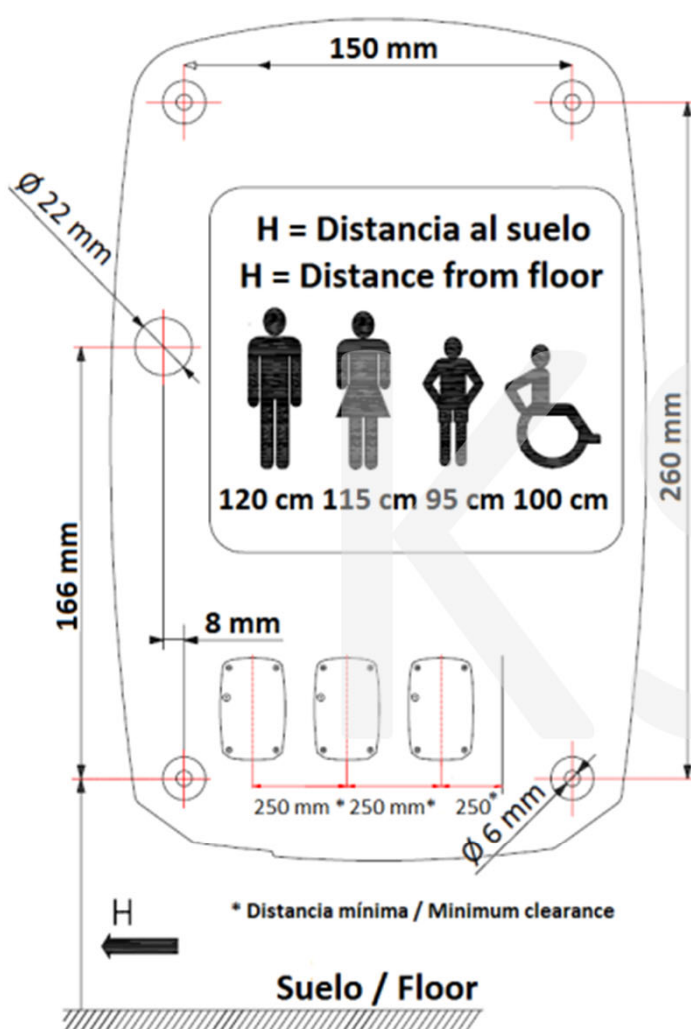

Ka Shing Enterprise (H.K.) Ltd.

ROOM 1706 NEW TERRITORIES TSUEN WAN HO LIK CENTRE, 66A SHA TSUI ROAD
Tel:26280661 Fax: 24902700
Email: project@kashingehk.com
Website: www.kashingehk.com

Ivan / Horace 26280661

E/ project@kashingehk.com

W/ <https://www.kashingehk.com/>



The Plug in Kit is compatible with the Machflow hand dryer and the Machflow hairdryer

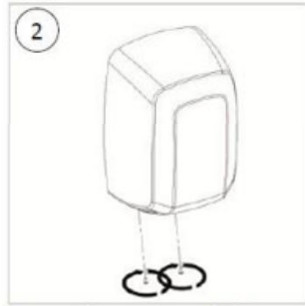

Unscrew the cover screws (x2)

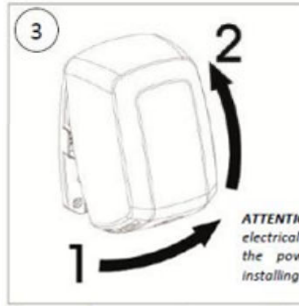

Remove the cover by a rotating movement

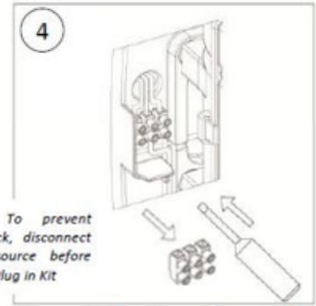

Disconnect the wires and remove the power strip

ATTENTION: To prevent electrical shock, disconnect the power source before installing the Plug in Kit



Unscrew the wall mount screws (x4)

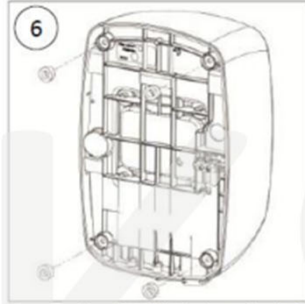

Remove the silent blocks from the back of the unit (x4)

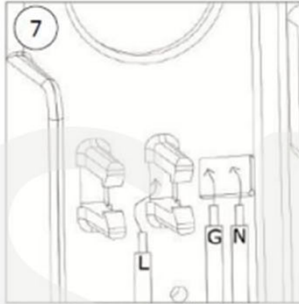

Route the wires through the holes to the back of the unit as shown on the picture

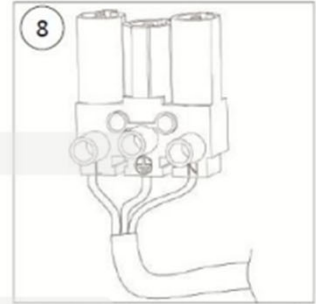

At the back of the unit, connect the wires to the fast connector following the engraved letters (N, L and Earth)

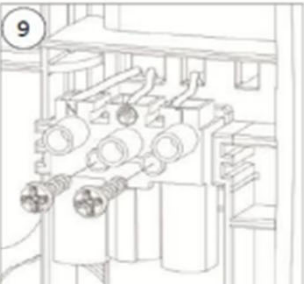

Fix the fast connector to the back of the unit using 2 screws

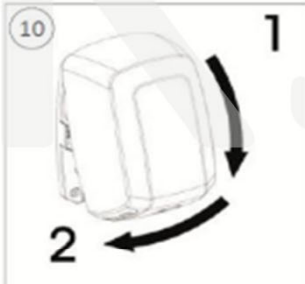

Close the dryer cover



Screw the cover fixing screws (x2)
Your dryer is now ready to be used on a Plug-in base



Same wall holes may be used for the Plug-in installation



Route the wires through the Plug-in base as shown on the picture



Screw the Plug-in base to the wall(x4)

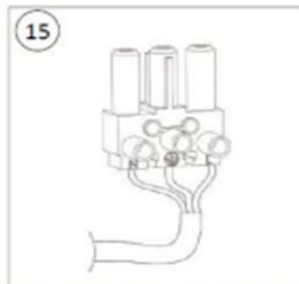

Connect the wires to the fast connector following the engraved

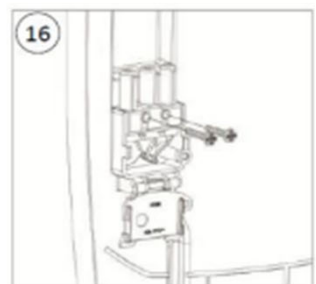

Fix the fast connector to the Plug-in base using 2 screws

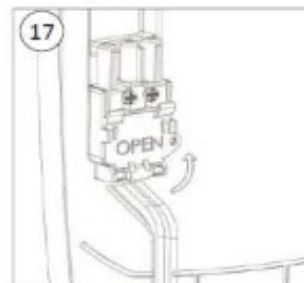

Close the security cover

Your Plug-in base is now ready to be used with a Plug-in dryer



Mount the dryer over the Plug-in base with a front to back movement



Screw the safety screw

Your dryer is ready to be used



Ka Shing Enterprise (H.K.) Ltd.

ROOM 1706 NEW TERRITORIES TSUEN WAN HO LIK CENTRE, 66A SHA TSUI ROAD
Tel:26280661 Fax: 24902700
Email: project@kashingehk.com
Website: www.kashingehk.com

Ivan / Horace 26280661

E/ project@kashingehk.com

W/ <https://www.kashingehk.com/>



DECLARACION DE CONFORMIDAD
CONFORMITY DECLARATION
DÉCLARATION DE CONFORMITE
ZUSTIMMUNGSERKLÄRUNG
DECLARAÇÃO DE CONFORMIDADE
DICHIARAZIONE DI CONFORMITÀ

Directivas de aplicación / Application Directives / Directives d'application / Verwendungsrichtlinien / Diretrizes de aplicações / Direttive di applicazione:	2014/35/EU, 2014/30/EU & 2011/65/EU INCLUDING AMENDMENTS
Conforme a las normas / According to the standards / Selon les normes / Den Normen gemäss / De conformidada com as normas / Conforme alle norme:	Electric safety Standards (LVD) IEC 60335-2-23:2016 + IEC 60335-2-23/A1:2019 IEC 60335-1:2010, COR1:2010, AMD1:2013, COR1:2014, AMD2:2016, COR1:2016 Electric safety standards (LVD) European equivalents: EN 60335-2-23:2003 + A1:2008 + A11:2010 + A2:2012 EN 60335-1:2012 EN 62233:2008 (incl. Corr.:2008) Electromagnetic compatibility (EMC) EN IEC 55014-1: 2021; EN IEC 55014-2: 2021 EN 61000-3-2: 2019; EN 61000-3-3: 2013 + A1:2019 CISPR 14-1:2020, CISPR 14-2:2020, IEC 61000-3-2:2018, AMD1:2020, IEC 61000-3-3:2013, AMD1:2017
Fabricante / Manufacturer / Fabricant / Hersteller / Produttore:	Mediclinics, S.A.
Dirección del fabricante / Address of the manufacturer / Adresse du Fabricant / Adresse des Herstellers / Endereço do fabricante / Indirizzo del produttore:	c/ Industria, 54, 08025 Barcelona (SPAIN)
Dirección importador / Address of the importer / Adresse de l'importateur / Adresse de Importeurs / Endereço do importador / Indirizzo dell'importatore:	-
Tipo de aparatos / Type of appliance / Genre d'appareils / Type der Geräte / Tipo de aparelhos / Tipo apparecchio:	Secadores de Manos/Hand dryers/ Seche-Mains/Händetrock / Secador de Mãos/Asciugamani
Referencia de modelo / Reference of the model / Référence du modèle / Modell-Referenz / Modello:	M09A; M09AC; M09ACS; M09AB; M09AE* (including KIT PLUGIN, FILTER, ION and adapter plate) *(stainless steel cover white painted)
<ul style="list-style-type: none">- The subject of the aforementioned declaration complies with the relevant Union harmonization legislation.- El objeto de la declaración descrita anteriormente es conforme con la legislación de armonización pertinente de la Unión.- The object of the declaration described above is in conformity with the relevant Union harmonisation legislation.- L'objet de la déclaration décrit ci-dessus est conforme à la législation d'harmonisation de l'Union applicable.- Der oben beschriebene Gegenstand der Erklärung erfüllt die einschlägigen Harmonisierungsrechtsvorschriften der Union.- O objeto da declaração acima descrito está em conformidade com a legislação de harmonização da União aplicável.- L'oggetto della dichiarazione di cui sopra è conforme alle pertinenti normativa di armonizzazione dell'Unione	
En/In/À/Em/In:	Barcelona
Nombre/Name/Nom/Namen/Nome:	Alfredo Bueno
Cargo/Title/Poste/Posten/Incarico:	Responsable de Calidad/Quality Manager
 07/03/2022 Firmado/Signature/Unterschrift/Asinado/Firma.	



Ka Shing Enterprise (H.K.) Ltd.

ROOM 1706 NEW TERRITORIES TSUEN WAN HO LIK CENTRE, 66A SHA TSUI ROAD
Tel:26280661 Fax: 24902700
Email: project@kashingehk.com
Website: www.kashingehk.com

Ivan / Horace 26280661

E/ project@kashingehk.com

W/ <https://www.kashingehk.com/>

Zertifikat

Certificate



Zertifikat Nr. *Certificate No.*
S 60137867

Blatt *Sheet*
0001

Ihr Zeichen <i>Client Reference</i>	Unser Zeichen <i>Our Reference</i>	Längstens gültig bis <i>Latest expiration date</i>	<i>(day/mo/yr)</i>
	0001--28111635 001	20.03.2024	

Genehmigungsinhaber *License Holder*
Mediclinics, SA
Industria, 54
08025 Barcelona
Spain

Fertigungsstätte *Manufacturing Plant*
Mediclinics S.A.
P.I. Can Oller - c/Catalunya, 9
08130 Sta. Perp. de Mogoda
Spagna

Prüfzeichen *Test Mark*



www.tuv.com
ID 1111218261

Geprüft nach *Tested acc. to*

EN 60335-1:2012+A11+A13
EN 60335-2-23:2003+A1+A11+A2
AfPS GS 2014:01 Par. 3.1

**Zertifiziertes Produkt (Geräteidentifikation)
*Certified Product (Product Identification)***

**Lizenzentgelte - Einheit
*License Fee - Unit***

Händetrockner (Hand Dryer)

Bezeichnung: (Models)	M09A ; M09AC ; M09ACS ; M09AO ; M09AE ; M09AB ; M09AX	10 2
Nennaufnahme: (Rated input)	600W or 1100W or 1350W or 1500W	
Nennspannung: (Rated voltage)	AC 220-240V, 50/60 Hz	
Schutzart: (Prot. degree)	IP23	
Schutzklasse : (Protection Class)	I	
Markenzeichen: (Trademark)	MCLS or Mediclinics	

ANLAGE (Appendix): 1.0

Dem Zertifikat liegt unsere Prüf- und Zertifizierungsordnung zugrunde.
Produkt und Fertigungsstätte erfüllen § 20 und § 21 des
Produktsicherheitsgesetzes.
*This certificate is based on our Testing and Certification Regulation.
Product and production fulfill par § 20 and § 21 of the
Product Safety Law.*

TÜV Rheinland LGA Products GmbH, Tillystraße 2, 90431 Nürnberg

Tel.: +49 221 806-1371 e-mail: cert-validity@de.tuv.com
Fax: +49 221 806-3935 <http://www.tuv.com/safety>

Ausstellungsdatum *Date of Issue* : 21.03.2019 (day/mo/yr)



Dipl.-Ing. J. Höhne



Ka Shing Enterprise (H.K.) Ltd.

ROOM 1706 NEW TERRITORIES TSUEN WAN HO LIK CENTRE, 66A SHA TSUI ROAD
Tel:26280661 Fax: 24902700
Email: project@kashingehk.com
Website: www.kashingehk.com

Ivan / Horace 26280661

E/ project@kashingehk.com

W/ <https://www.kashingehk.com/>